



Plasmor Ltd
Womersley Road, Knottingley
West Yorkshire, WF11 0DL

BS EN 771-3 (2011 + A1:2015)

Bison EX 140 NARROW T Block 7.3N/mm² BISONEX140N

Loadbearing and non-loadbearing applications in all forms of walling including single leaf, cavity and partitions.

Dimensions (mm)	340 / 295 x 140 x 140
Dimensional Tolerances:	Category D1
Configuration:	Solid
Compressive Strength:	7.3N/mm ²
Dimensional Stability:	=< 0.60mm/m
Shear Bond Strength:	0.15N/mm ²
Flexural Bond Strength:	NPD
Reaction to Fire:	Euro Class A1
Water Absorption:	NPD
Water Vapour diffusion coefficient:	5/15
Gross Dry Density:	950 kg /m ³
Configuration:	Group 1 Solid
Thermal Conductivity	0.28 W/m.K (λ_{10} , dry, mat P = 50%)
Durability against freeze-thaw:	Not to be left exposed

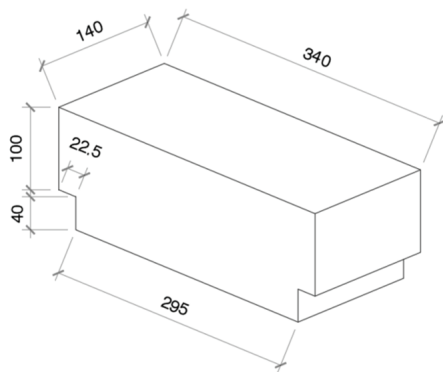

See also Declaration of Performance BISONEX140N

technical@plasmor.co.uk